

Which Circuits Work!?

Which circuits will light up the LED when the button switch is pushed? Why or why not?

TECHNICAL NOTE

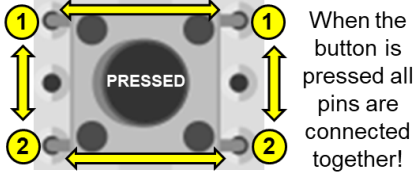

TECHNICAL NOTE

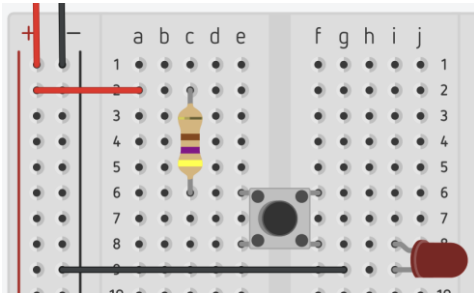
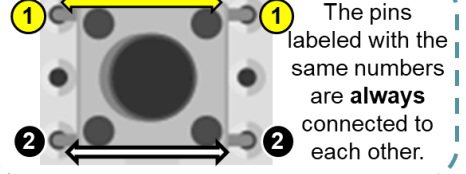

YES, IT WORKS!
 NO, IT DOESN'T WORK!
 Explain your answer:

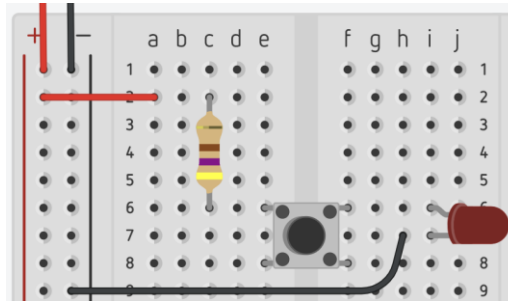

YES, IT WORKS!
 NO, IT DOESN'T WORK!
 Explain your answer:

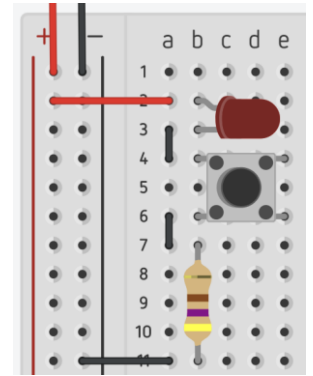

YES, IT WORKS!
 NO, IT DOESN'T WORK!
 Explain your answer:

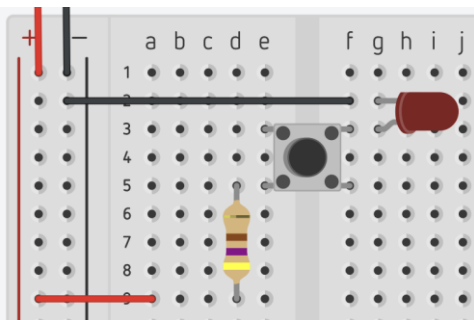

YES, IT WORKS!
 NO, IT DOESN'T WORK!
 Explain your answer:

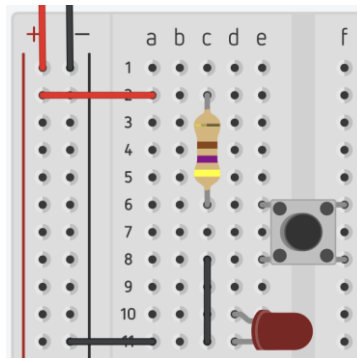

YES, IT WORKS!
 NO, IT DOESN'T WORK!
 Explain your answer:

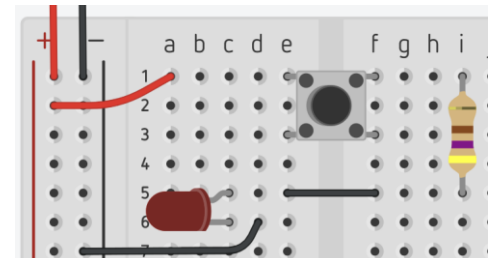

YES, IT WORKS!
 NO, IT DOESN'T WORK!
 Explain your answer:

